

GARAGE DOOR OPENER

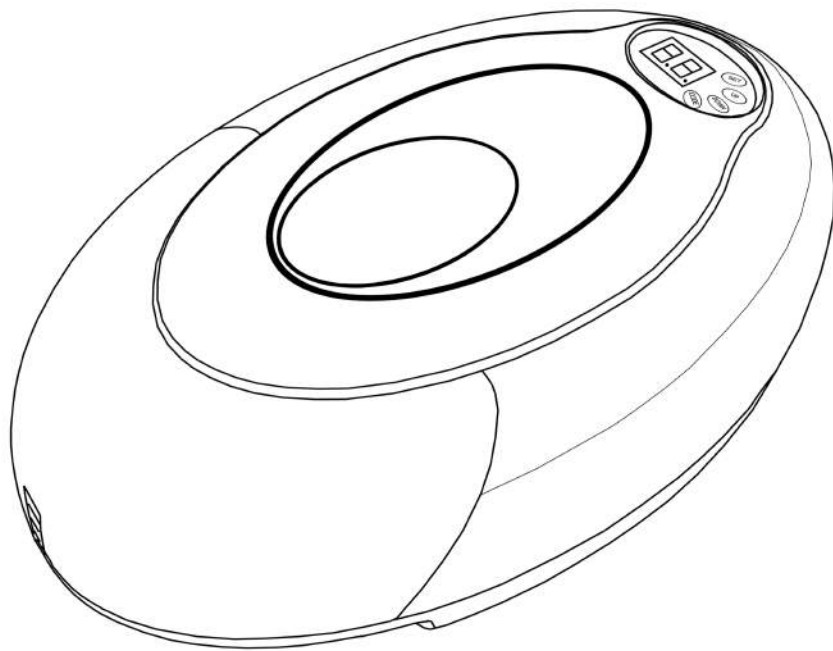

PAX-2E

WARNING: IT IS VITAL FOR THE SAFETY OF ALL PERSONS INSTALLING AND USING THIS OPENER TO FOLLOW THE INSTALLATION INSTRUCTIONS AND SAFETY WARNINGS. FAILURE TO COMPLY MAY RESULT IN SERIOUS PERSONAL INJURY AND/OR PROPERTY DAMAGE AND FAILURE OF THE OPENER SYSTEM.

INSTALLATION & OWNERS MANUAL

1.Functions

Micro intellectual control —— One button to control open, stop and close.

The light is on while opening or closing the door, three minutes later the light is off automatically. The unit running is controlled by computer program. Test the force of open or close the door, the optional function is photo beam, auto-close, lock door, etc. The door pauses momentarily then rebounds when it reaches the hinders on the closing way. The protecting functions are overload, over hot or low power input, etc.

DC motor —— Low noise, soft start, slow stopping to protect the unit and make sure it can be used for a long time.

LED display —— Working situation can be shown on the LED screen.

Decoding —— Rolling code.

Manual Disengagement—— Open and close the door by hand without power.

Optional Functions —— Photo beam, battery backup and wall button.

2. Technical Specifications

Power Input	220V AC $\pm 10\%$ 50~60Hz	Reception frequency	433.92MHz
Motor	24V DC	Decoding	Rolling Code
Working Temperature	$> -20^{\circ}\text{C}$, $< +50^{\circ}\text{C}$	Transmitter power	27A 12V Battery
Relative Humidity	$\leq 90\%$	Globe	24V 5W
Open and close force	600N 800N 1000N 1200N	Courtesy light time	3 minutes

3. Installation

3.1 Recommended Tools

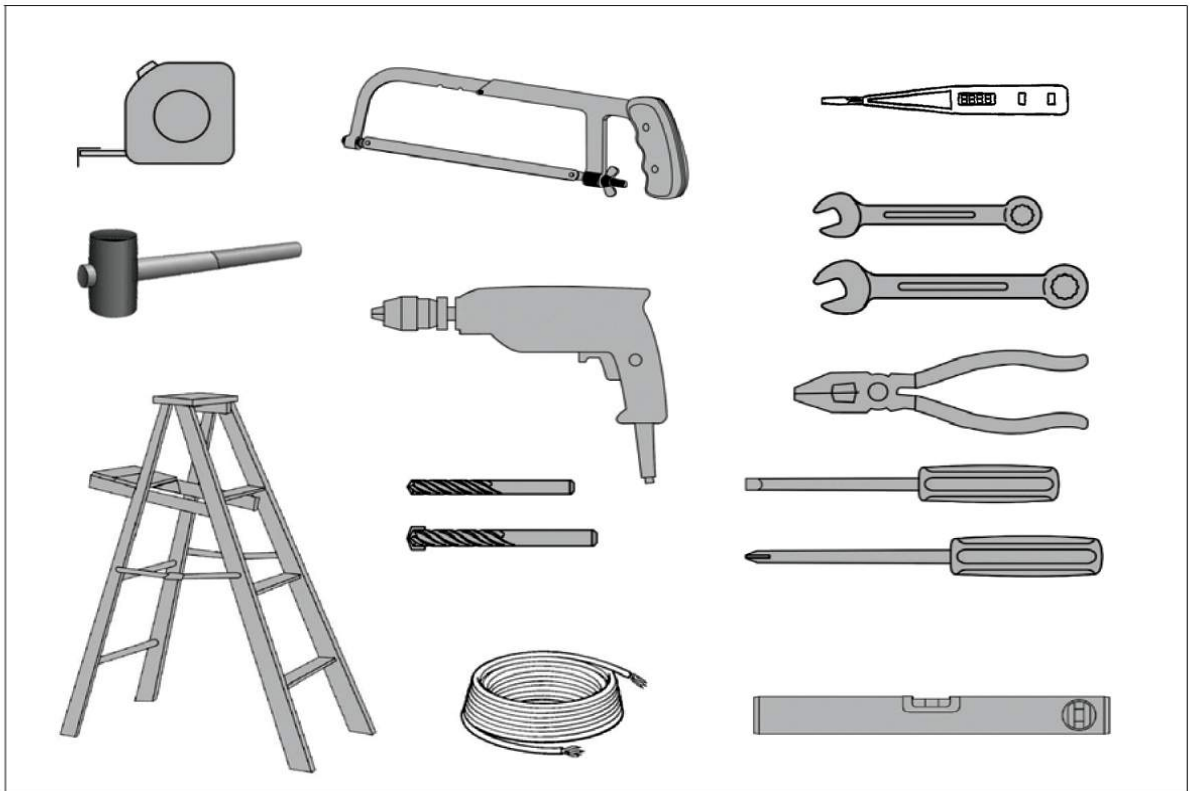

3.2 Installing the Operator and Rail

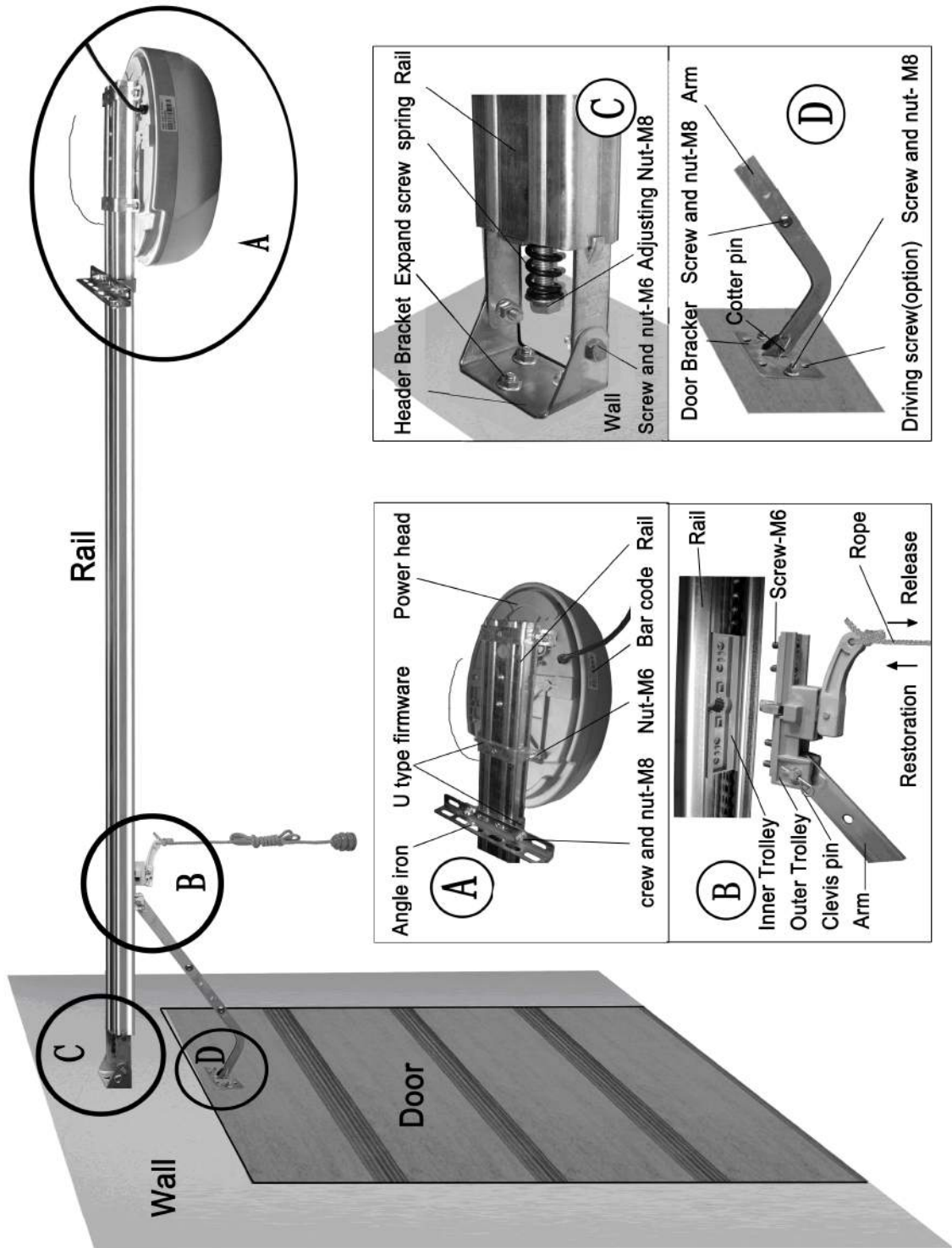

4. Control panel and Transmitter



Control panel

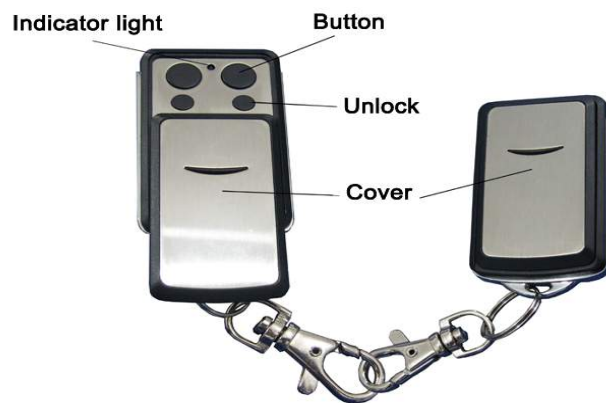





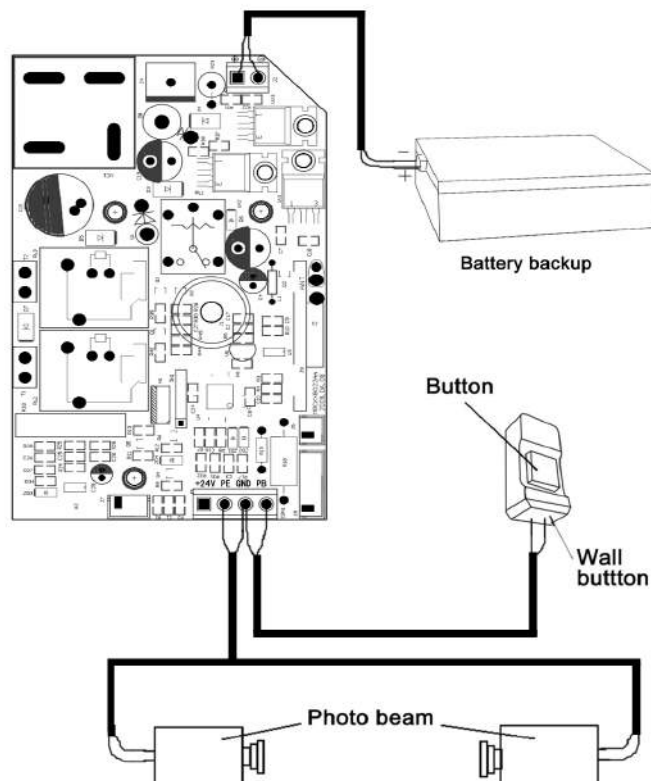















Transmitter

5. Optional Terminals and Connections







6. Programming the Operator

6.1	Preparing	
6.1.1	Keep trolley locked, Pull and push the door by hand, make sure the trolley connects with the shuttle.	
6.1.2	Turn on the power, the courtesy light is on for several seconds, at the same time, the LED displays the number from 99 to 11. Then the operator turns to standby situation.	
6.1.3	At last, it displays "- -".	
6.2	Setting Open and Close Positions	
6.2.1	Press and hold SET until it displays "P1".	
6.2.2	Press SET, it displays "OP".	
6.2.3	Then press and hold UP, it flashes "OP".	
6.2.4	When the door has reached the open position, press SET, it displays "CL".	
6.2.5	Then press and hold DOWN, it flashes "CL". When the door has reached the closed position, press SET.	
6.2.6	The door opens and closes automatically to map the open and close sensitivity force requirements.	
6.2.7	It displays "- -" to show setting is complete.	
6.3	Self Learning Transmitter	
6.3.1	When the unit has stored 20 codes, it flashes "Fu", or preventing coding mistakes, it is necessary to cancel all the stored codes.	
6.3.2	Press and hold CODE, it displays "Su".	
6.3.3	Hold more than 8 seconds, it flashes "dL", all the codes were cancelled.	
6.4	Adding or Changing Transmitters	
6.4.1	Press CODE, it displays "Su".	
6.4.2	Press a button on the transmitter, then release and press the same button again, "Su" flashes,	
6.4.3	Then it displays "- -" to show setting is complete. Repeat up steps to code a maximum of 20 different transmitters' and/or buttons.	

6.5	Force Adjustments	
6.5.1	Press and hold SET, it displays "P1".	P1
6.5.2	Press UP once, it displays "P2".	P2
6.5.3	Press SET once again, it will show the current situation. Press UP to increase the force one degree or press DOWN to decrease one degree. Maximum degree is "F9", minimum is "F1".	F9 F1
6.5.4	Press SET to confirm. The default setting is "F5".	F5
6.5.5	 After finishing all the setting, please check the force to make safe.	
6.6	Photo Beam	
6.6.1	Press and hold SET, it displays " P1" .	P1
6.6.2	Press UP twice, it displays "P3" .	P3
6.6.3	Press SET to show current situation. Press UP once it displays "H1", the photo beam is enabled. Press down once, It displays "H0", the photo beam is disabled. Press SET to confirm and quit.	H0 H1
6.6.4	 If you do not use photo beam device, please make sure it displays" H0to close this function.	H0
6.7	Auto-Close ON/OFF	
6.7.1	Press and hold SET, it displays "P1".	P1
6.7.2	Press UP three times, it displays "P4".	P4
6.7.3	Press SET to show current situation. Press UP to increase the auto-close one minute or press DOWN to decrease one minute. Maximum degree is "b9" , minimum is "b0". Press SET to confirm.	b0 b9
6.7.4	 The default setting is " b0", " b0" shows auto-close off. This function works when the door reaches the open position.	b0
6.8	Lock Door	
6.8.1	Press and hold SET, it displays "P1".	P1
6.8.2	Press UP four times, it displays "P5".	P5
6.8.3	Press SET to show current situation. Press UP, it displays "Lc", lock door function works or press DOWN, It displays "uL", lock door function doesn't work. Press SET to confirm the function you need.	Lc uL
6.8.4	 When you use uncovered transmitters,it is recommended using lock door function. This function works when the door reaches the closed position, you can't open the door until press the' unlock'button first.	

7.Owners' Guide

7.1	Attention in use		
7.1.1		At the first time of using the door, please test the driving system to see if it moves well. (Test method: unlock the trolley, pull and push the door by hand.)	
7.1.2		Connected with the appropriate power and socket by professionals, and connected the earthing wire with earth.	
7.1.3		Using the transmitters in your sight. Do not stand or walk under a moving door. The transmitters should be out of reaching of children.	
7.1.4		Make sure the door out off fire, moisture, electromagnetism and some other places.	
7.1.5		Check at least twice a year to make sure the door is properly balanced and that all working parts are in good working condition. Adjust the tensile force of chain. Add suitable amount of lubricant to the active.	
7.2	Examination Guide		
7.2.1	Problem	Causes	Solution
7.2.2	The chain is noisy.	The chain is too loose.	Adjust nut-M8 referring to 3.2.C.
7.2.3	The motor does not work.	The socket is not well connect or the fuse is broken.	Check the socket or replace the fuse.
7.2.4	After setting open and close positions, the motor does not work.	The screws of fixing the Hall components are loose or program mistakes.	Tighten the screws or resetting open and close positions.
7.2.5	The door can't be closed.	Photo beam function works.	Cancel the photo beam function, referring to 6.6.
7.2.6	The wall button works well, but the transmitter doesn't work.	No transmitter learning or transmitter battery is power off.	Code referring to 6.4 or change new transmitter battery.
7.2.7	Transmitter distance is too short.	The transmitter battery is nearly power off.	Change new battery.